

Collect. Czech. Chem. Commun.
2001, 66, 1593–1602

**Specificity and Non-Specificity
in the Sensitized CO₂-Laser-Induced
Reaction of Tetrachloroethene**

Boyd L. Earl and Richard L. Titus

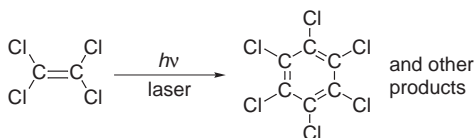

Collect. Czech. Chem. Commun.
2001, 66, 1603–1614

**Benzophenone-Sensitized Peroxidation
in Compressed Lipid Monolayers
at Air–Water Interface**

Dejan Z. Markovic

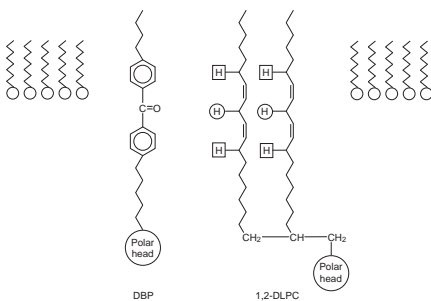

Collect. Czech. Chem. Commun.
2001, 66, 1615–1622

**DC Polarographic and UV Spectrometric
Studies of Substituted Furo[3,2-*b*]- and
Furo[2,3-*b*]pyrroles**

Darina Romanová, Anna Vachálková,
Katarína Horváthová and Alžbeta Krutošíková

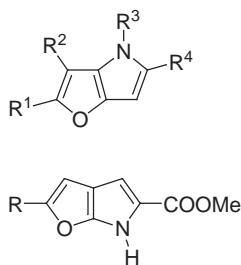

Collect. Czech. Chem. Commun.
2001, 66, 1623–1637

**Resonance Energy in Benzene
Derivatives with a Variable
Functional Group**

Otto Exner and Stanislav Böhm

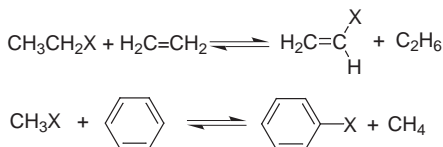

Collect. Czech. Chem. Commun.
2001, 66, 1638–1658

Construction of Interconnected Acidity Functions Based on *ortho* Substituted Anilines and *N*-Methylanilines as Indicators

Oldřich Pytela, Jiří Kulhánek,
Eva Jirásková and Tatjana Nevěčná

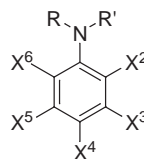

Construction of acidity functions

Collect. Czech. Chem. Commun.
2001, 66, 1659–1664

Novel Systems for Selective Cation Detection: Application of a Lipophilic Carborane Anion in Polymeric Ion-Selective Electrodes

Martin Krondak, Radko Volf
and Vladimír Král

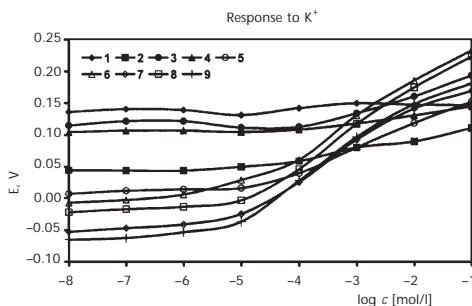

Collect. Czech. Chem. Commun.
2001, 66, 1665–1681

Alkylation of Partially Protected Xylofuranoses and Tetrityls with (2,2,3,3,4,4,5,5,6,6,7,7,7-Tridecafluoroheptyl)oxirane and the Stability of Protecting Acetal Groups Towards Lewis Acid-Type Catalyst

Karel Kefurt, Jitka Moravcová, Šárka Bambasová, Kateřina Buchalová, Barbora Vymětalíková, Zdeňka Kefurtová, Jan Staněk and Oldřich Paleta

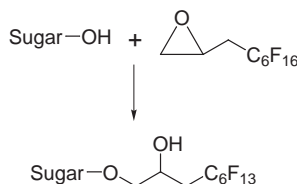

Collect. Czech. Chem. Commun.
2001, 66, 1682–1690

Chemical Characterization and Synthesis of the Major Component of the Sex Pheromone of the Sugarcane Borer *Diatraea saccharalis*

Aleš Svatoš, Blanka Kalinová, Jiří Kindl,
Jelena Kuldová, Oldřich Hovorka,
Ruth Rufino Do Nascimento and
Neil J. Oldham

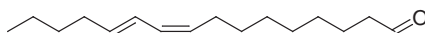

Collect. Czech. Chem. Commun.
2001, 66, 1691–1697

**Utilisation of 6-Amino-2,3-dimethyl-
 quinoxaline for the Synthesis of
 Tricyclic Pyridoquinoxalines via
 Gould–Jacobs Reaction**

Jozef Saloň, Viktor Milata,
 Nadežda Prónayová and Ján Leško

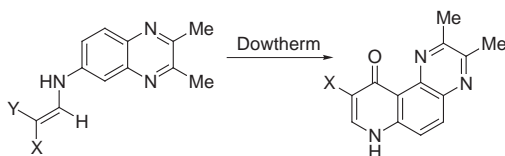

Collect. Czech. Chem. Commun.
2001, 66, 1698–1706

**Interactions of 1-[(S)-3-Hydroxy-2-
 (phosphonomethoxy)propyl]cytosine
 (Cidofovir) Diphosphate with DNA
 Polymerases α , δ and ϵ^***

Gabriel Birkuš, Ivan Votruba,
 Miroslav Otmar and Antonín Holý

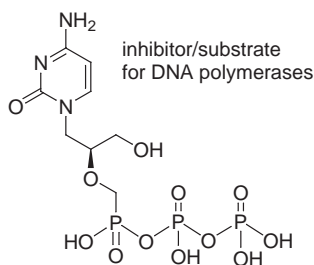

Collect. Czech. Chem. Commun.
2001, 66, 1707–1719

**Enzymological Characterization of Secreted
 Proteinases from *Candida parapsilosis*
 and *Candida lusitanae***

Olga Hrušková-Heidingsfeldová, Jiří Dostál,
 Petr Hamal, Jarmila Pazlarová, Tomáš Ruml
 and Iva Pichová

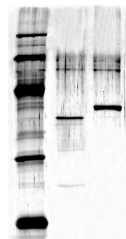

Collect. Czech. Chem. Commun.
2001, 66, 1720–1728

**Identification of HL60 Proteins
 Affected by 5-Aminolevulinic
 Acid-Based Photodynamic Therapy
 Using Mass Spectrometric Approach**

Petr Halada, Petr Man, Dana Grebeňová,
 Zbyněk Hrkal and Vladimír Havlíček

